



SNAC 2022		Form A
Pilot ID	SAA Excellence Known	Flight #

No	Symbol	Cat. No.	K	Total K	Grade	Pos	Remarks	Item	K	Grade
1		6.2.1.1 9.1.1.5 9.1.5.3	15 14 6	35	.			Pos.	35	
								Harm.	0	
2		8.5.4.1 9.1.2.2 9.9.7.4 9.1.3.1 9.1.3.3	11 6 15 2 6	40	.			Fig K	Total K	
								350	385	
Penalties										
3		7.2.1.2 9.2.3.4 9.9.8.2 9.1.3.6	8 9 13 10	40	.			Too Low		
								Too High		
								Interruptions		
								Insertions		
4		2.4.3.1	42	42	.			Trg Violation		
								Wing Rocks		
								Disqual Fig		
								Other(note...)		
Final Freestyle										
5		8.8.1.1 9.1.1.1 9.4.5.3	18 6 8	32	.			Duration	Min	Sec
Judges Details										
6		1.3.11.4 9.12.1.5 9.1.5.1 9.1.2.1 9.1.2.3	20 6 2 4 8	40	.			Signature		
								Name		
								Number		
7		1.2.7.1 9.2.1.4 9.10.4.4 9.1.4.2	13 13 13 4	43	.					
8		5.2.1.1 9.10.6.3 9.1.5.1	17 19 2	38	.					
9		7.2.4.1 9.2.3.6 9.1.3.7 9.1.3.5	8 12 11 9	40	.					

ALL Pilot
 A/C



SNAC 2022		Form B
Pilot ID	SAA Excellence Known	Flight #

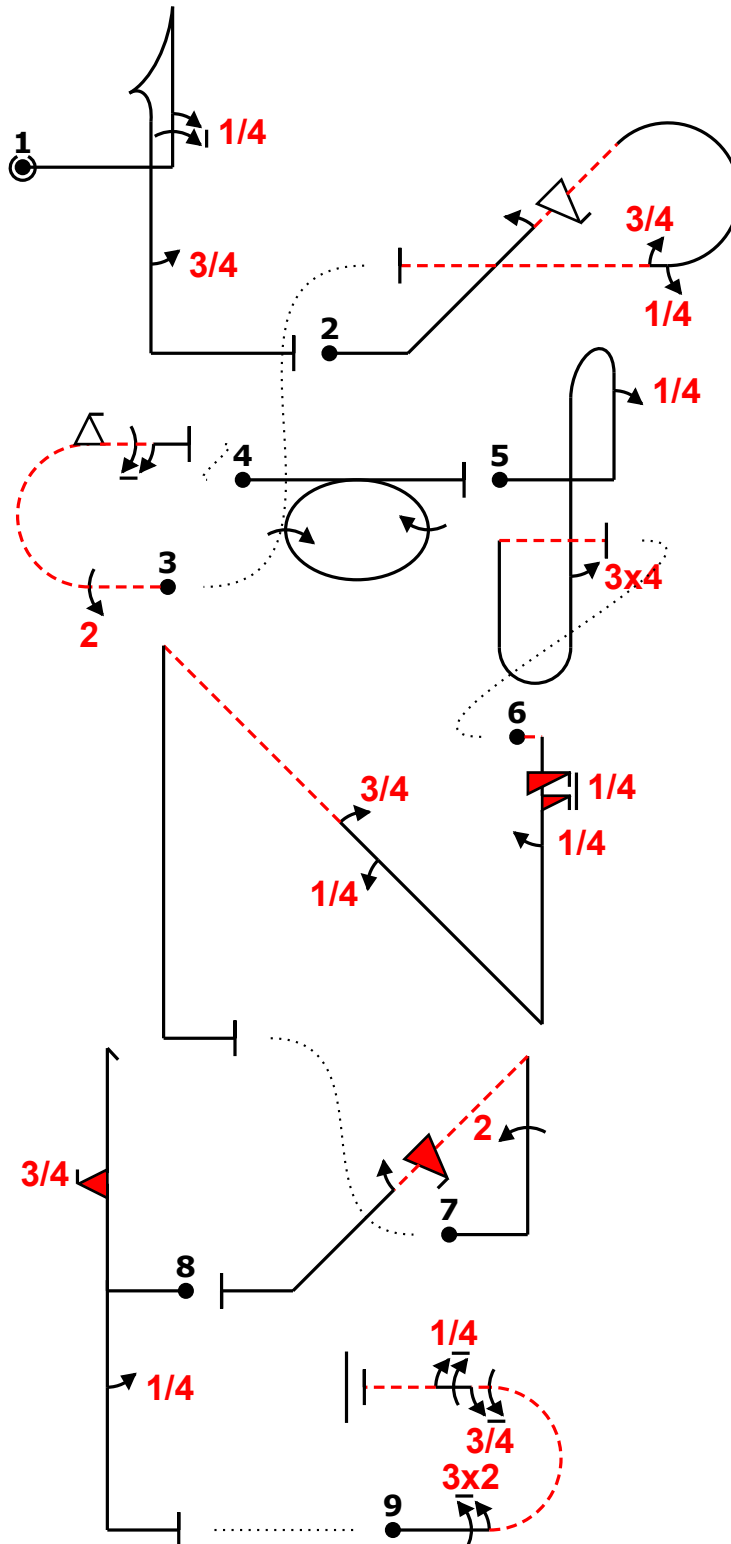
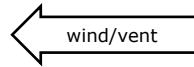

,5ta3.> 2,frc4,3- (-9,18) -22m2f,6+^ (-1,2) 4j2 ,4bb(34)-> (-9,11) ^^^-^^5is,"|4.'in(.''4'',3...').... (8,11) 22kif,2 ''3i f.h''4.. (8,0) 32m7,5-

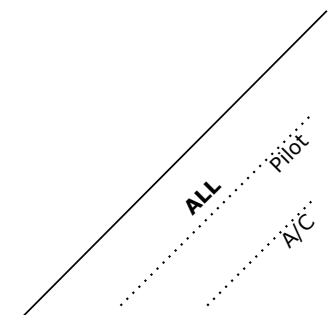



SNAC 2022		Form C
Pilot ID	SAA Excellence Known	Flight #

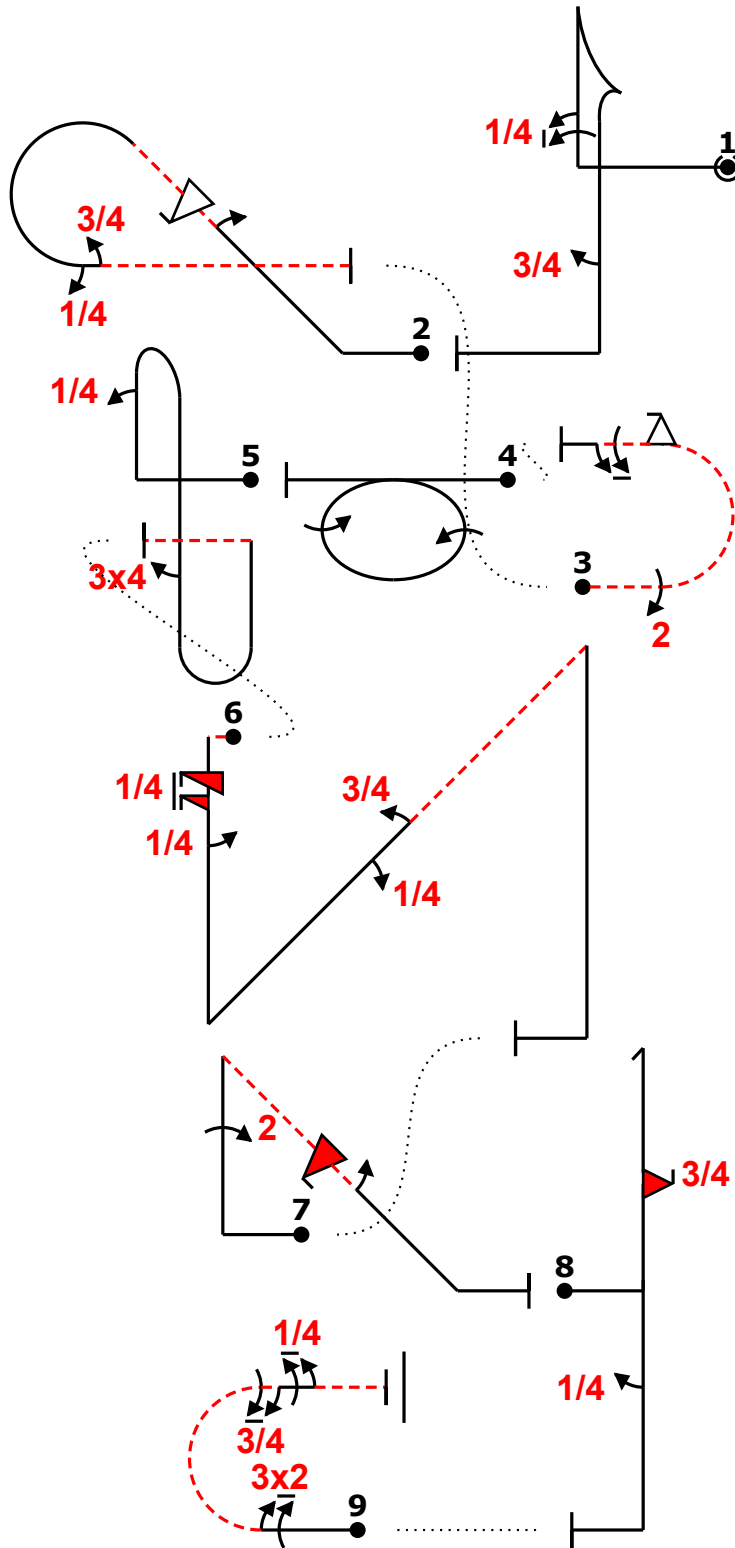
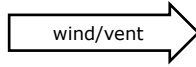

,5ta3.> 2,frc4,3- (-9,18) -22m2f,6+^ (-1,2) 4j2 ,4bb(34)-> (-9,11) ^^^^5is,|"4.'in(.''4''',3...').... (8,11) 22kif,2 ''3i f.h''4.. (8,0) 32m7,5-

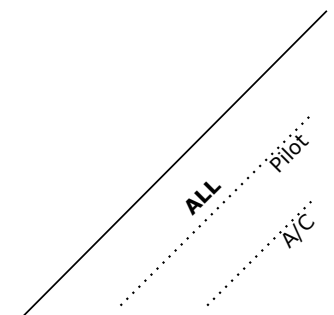



SAA	Excellence	2022
Known		SNAC

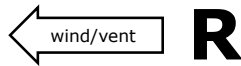

Figure K
350
Total K
385

Judges Name	
Signature	Number

Flight #

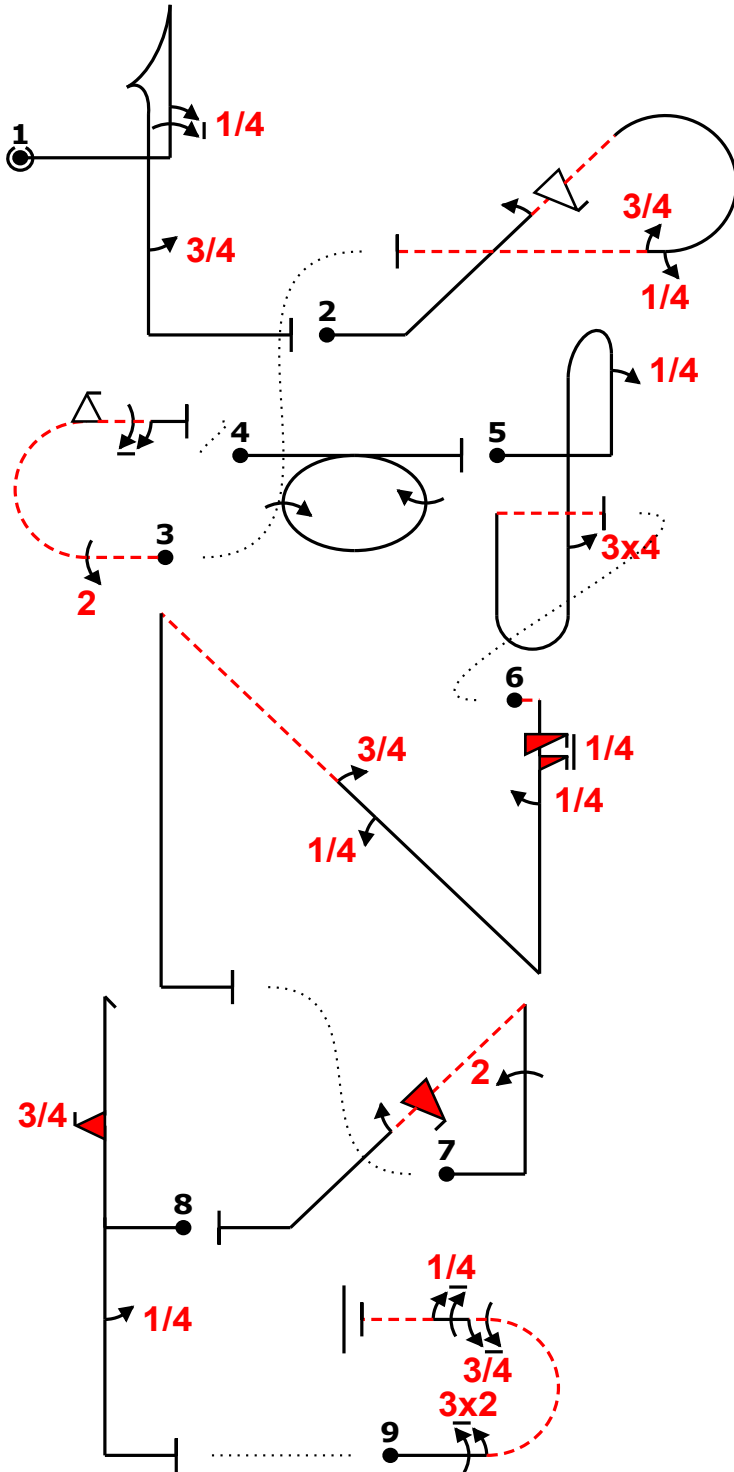

Fig	Grade	Pos	Remarks
1	.		
2	.		
3	.		
4	.		
5	.		
6	.		
7	.		
8	.		
9	.		

Positioning	35	.
-------------	----	---

Too Low		Trg Violation	
Too High		Wing Rocks	
Interruptions		Disqual Fig	
Insertions		Other(note...)	

,5ta3-> 2,frc4,3- (-9,18) -22m2f,6+^ (-1,2) 4j2 ,4bb(34)-> (-9,11) ^^^^5is,"|4.'in('4',3...'
).... (8,11) 22kif,2 ''3if.h''4... (8,0) 32m7,5-

Fig 1	K	Fig 2	K	Fig 3	K	Fig 4	K	Fig 5	K	Fig 6	K	Fig 7	K	Fig 8	K	Fig 9	K
6.2.1.1	15	8.5.4.1	11	7.2.1.2	8	2.4.3.1	42	8.8.1.1	18	1.3.11.4	20	1.2.7.1	13	5.2.1.1	17	7.2.4.1	8
9.1.1.5	14	9.1.2.2	6	9.2.3.4	9			9.1.1.1	6	9.12.1.5	6	9.2.1.4	13	9.10.6.3	19	9.2.3.6	12
9.1.5.3	6	9.9.7.4	15	9.9.8.2	13			9.4.5.3	8	9.1.5.1	2	9.10.4.4	13	9.1.5.1	2	9.1.3.7	11
		9.1.3.1	2	9.1.3.6	10					9.1.2.1	4	9.1.4.2	4			9.1.3.5	9
		9.1.3.3	6							9.1.2.3	8						
	35		40		40		42		32		40		43		38		40

Pilot: ALL

A/C:

Team: SUI

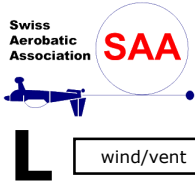

SAA	Excellence	2022
Known		SNAC

Figure K
350
Total K
385

Judges Name	
Signature	Number

Flight #

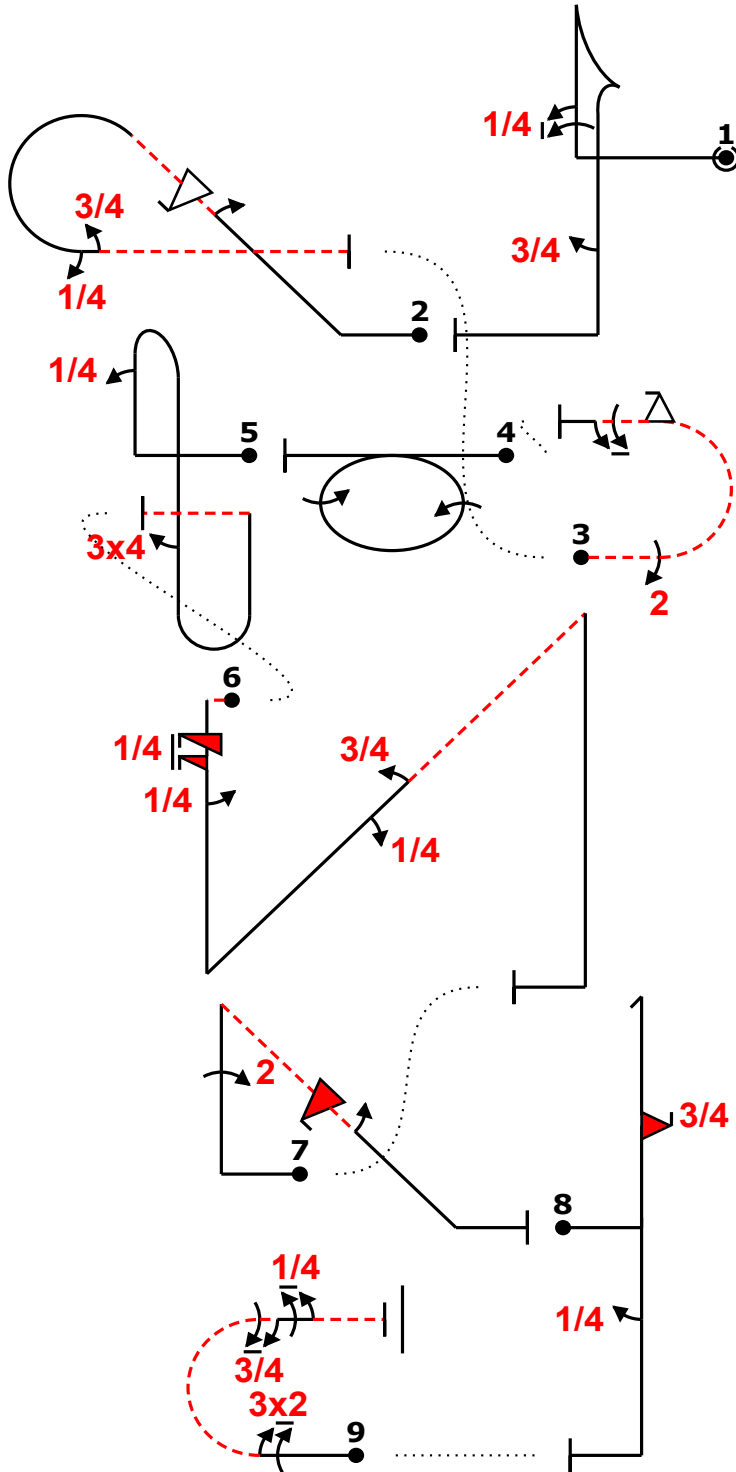

Fig	Grade	Pos	Remarks
1	.		
2	.		
3	.		
4	.		
5	.		
6	.		
7	.		
8	.		
9	.		

Positioning	35
-------------	-----------

Too Low		Trg Violation	
Too High		Wing Rocks	
Interruptions		Disqual Fig	
Insertions		Other(note...)	

,5ta3-> 2,frc4,3- (-9,18) -22m2f,6+~ (-1,2) 4j2 ,4bb(34)-> (-9,11) ~~~~'5is,|"4.'in(.''4''',3...'
).... (8,11) 22kif,2 ''3if.h''4... (8,0) 32m7,5-

Fig 1	K	Fig 2	K	Fig 3	K	Fig 4	K	Fig 5	K	Fig 6	K	Fig 7	K	Fig 8	K	Fig 9	K
6.2.1.1	15	8.5.4.1	11	7.2.1.2	8	2.4.3.1	42	8.8.1.1	18	1.3.11.4	20	1.2.7.1	13	5.2.1.1	17	7.2.4.1	8
9.1.1.5	14	9.1.2.2	6	9.2.3.4	9			9.1.1.1	6	9.12.1.5	6	9.2.1.4	13	9.10.6.3	19	9.2.3.6	12
9.1.5.3	6	9.9.7.4	15	9.9.8.2	13			9.4.5.3	8	9.1.5.1	2	9.10.4.4	13	9.1.5.1	2	9.1.3.7	11
		9.1.3.1	2	9.1.3.6	10					9.1.2.1	4	9.1.4.2	4			9.1.3.5	9
		9.1.3.3	6							9.1.2.3	8						
	35		40		40		42		32		40		43		38		40

Pilot: ALL

A/C:

Team: SUI

